

Article number: 0107057

Description: Retaining ring AK 40 DIN 983

Measures

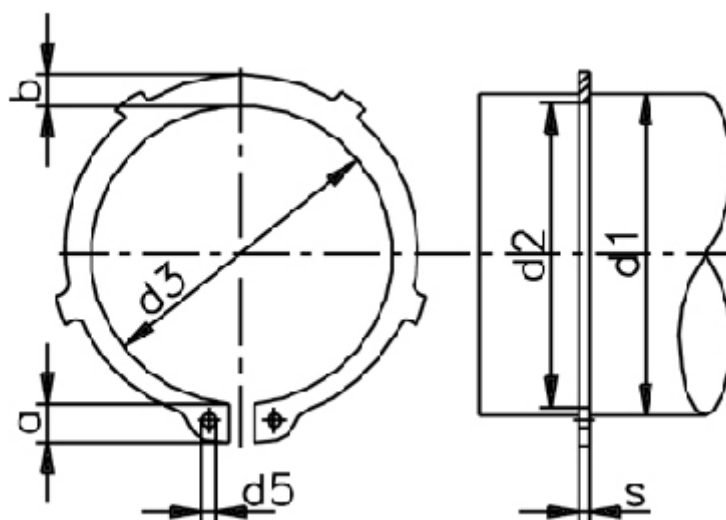

a max	= 7.2	FN kN	= 25.30	Number of serrations	= 6
AN mm ²	= 152.0	FRg kN	= 9.5	s	= 1.75
b	= 4.2	FR kN	= 51.0	t	= 1.25
d1	= 40	g	= 2.0	tol	= -0.25
d2	= 37.5	K kN-mm	= 96.9	tol	= -0.06
d3	= 36.5	m min	= 1.85	tol	= +0,39-0,90
d5 min	= 2.5	n abl x 1000	= 14	Tong	= ZGA-3
Description	= AK 40	Nominal drive	= 3.8	Weight kg/1000	= 7.00